

Improved Monitoring of Radiation Use During Fluoroscopic Procedures

S Panahipour, M Street, J Duncan



Purpose

- Fluoroscopic procedures often cause much higher patient doses than CT scans
 - Risk of skin injuries and future neoplasms
- Need to develop a systematic approach
 - Monitoring and optimizing exposure
- Use data to predict exposure for high volume procedures
 - Establish reference levels and determine what factors cause deviation from expectation

Methods

- Data capture and aggregation
 - Combine data captured in the Radiology Information System (RIS, Syngo) with records of radiation use (DICOM-SRs) generated by newest angio rooms

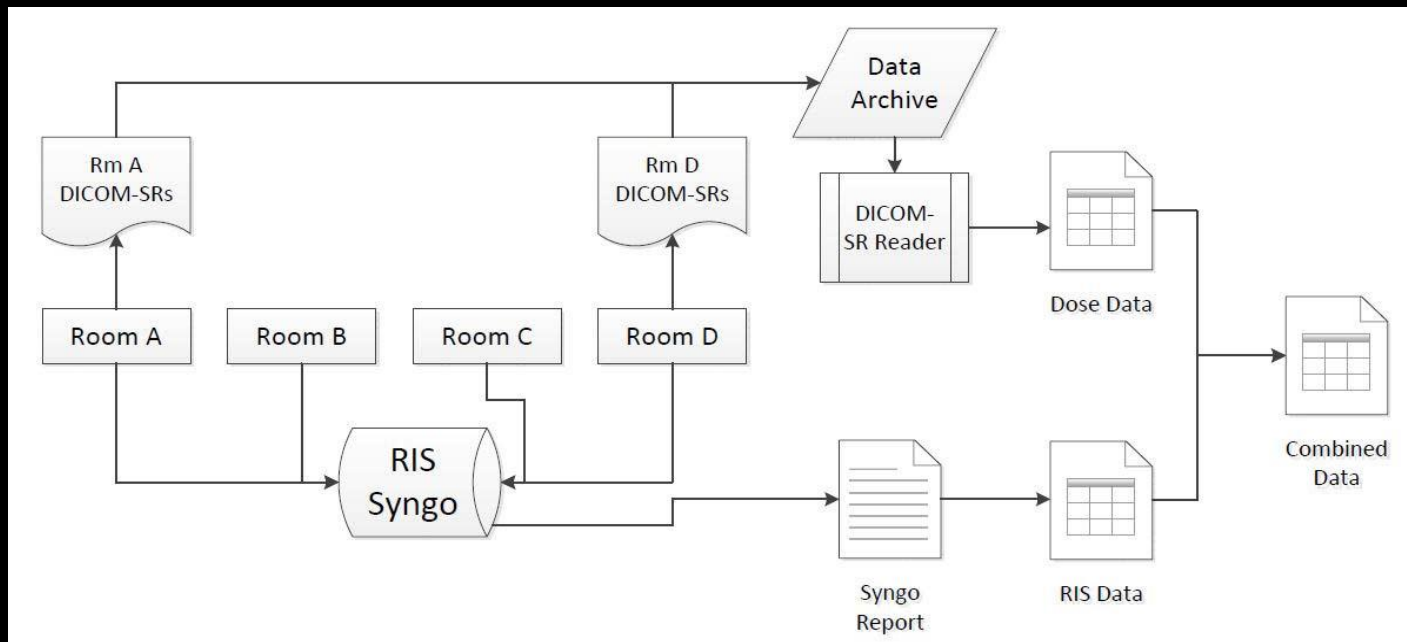

Data for All IR Procedures

- Sept 2011 improvement
 - Low dose protocols became default and resulted in a substantial reduction for all procedures performed in those rooms. Result has been sustained for 2 years.

Weekly Average Ref Point Air Kerma/Procedure (Rm 812)

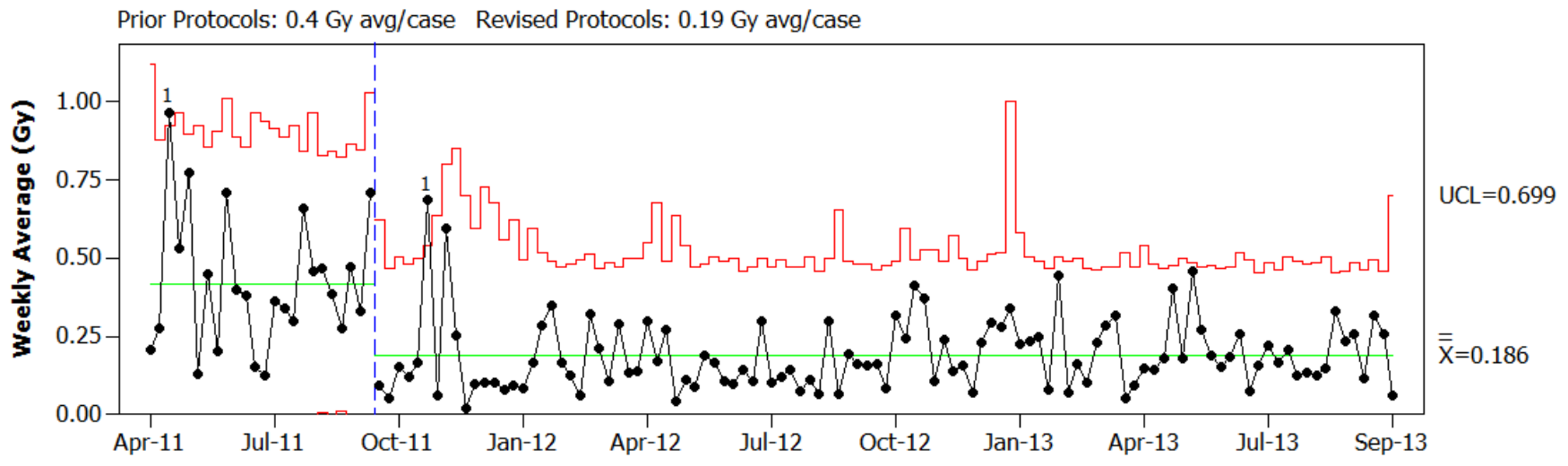

Data collection and analysis described in [JACR online publication](#)

Tracking Use of Last Image Hold

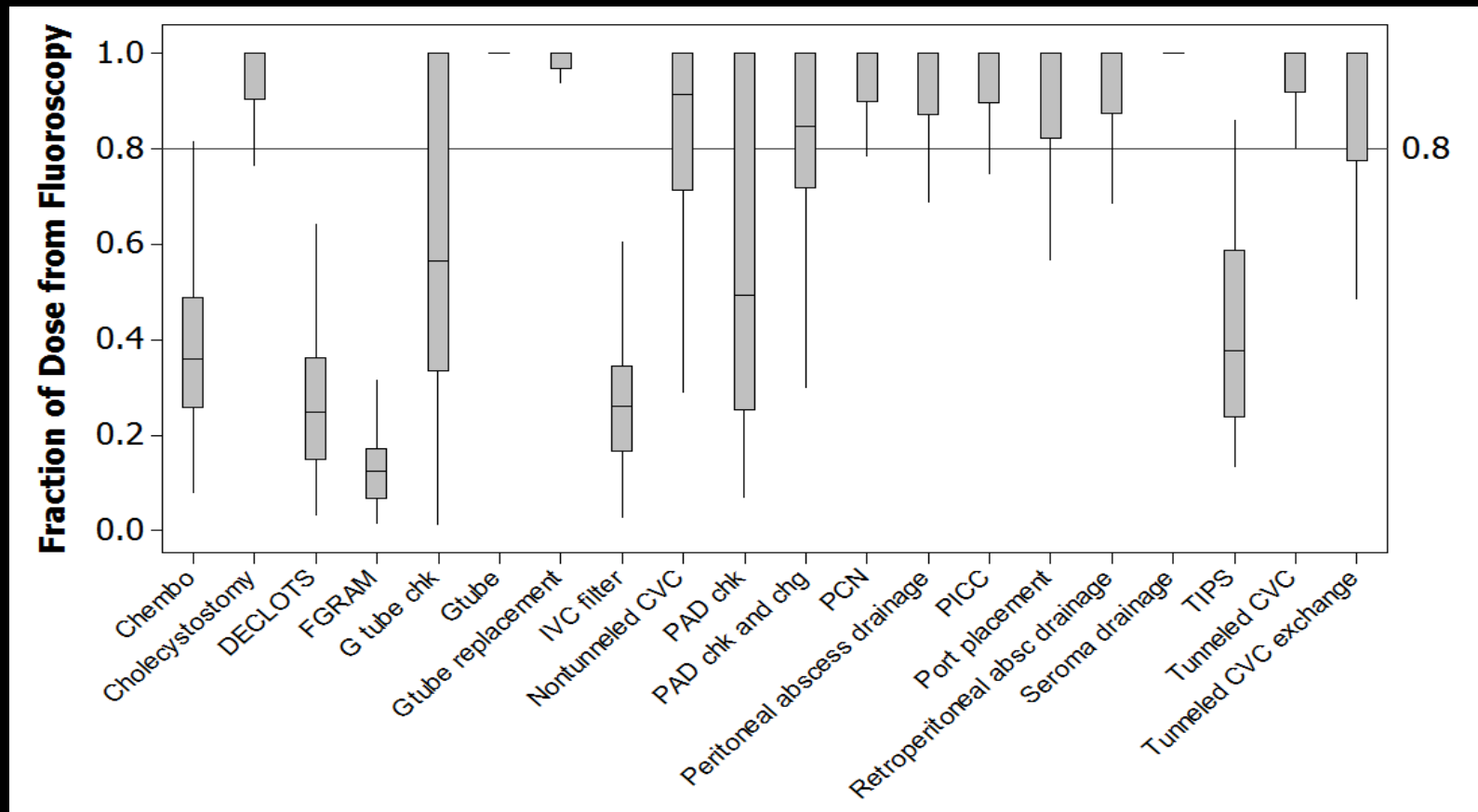

A high fluoroscopy fraction indicates use of last image hold for routine documentation of imaging findings. DSA heavy procedures such as Chembo, TIPS, etc had a lower fluoroscopy fraction.

Tracking Procedure Specific Data

I-MR Chart of Dose Metric for IVC Filters

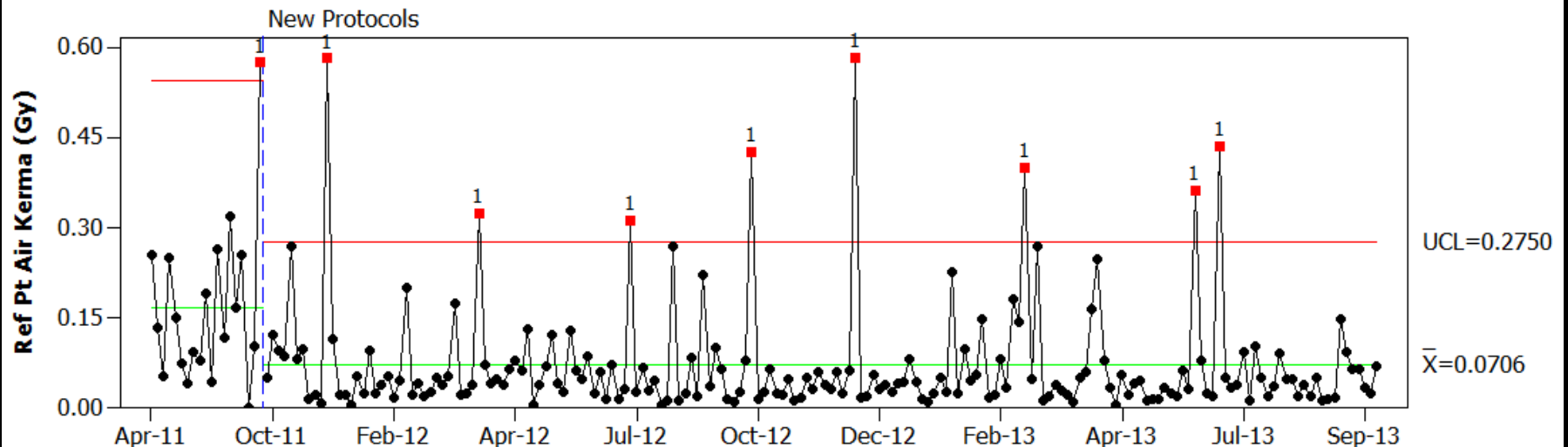

Average value for IVC filter placement (CPT 37191) dropped from 0.17 to 0.07 Gy with the Sept 2011 protocol changes. The statistical process control software (Minitab 16) calculated an upper control limit (UCL) of 0.28 Gy and identified 8 cases that warrant investigation for evidence of causal factors impacting system performance.

Further Analysis of IVC Filters

I-MR Chart of Fluoroscopy Time for IVC Filter Placement

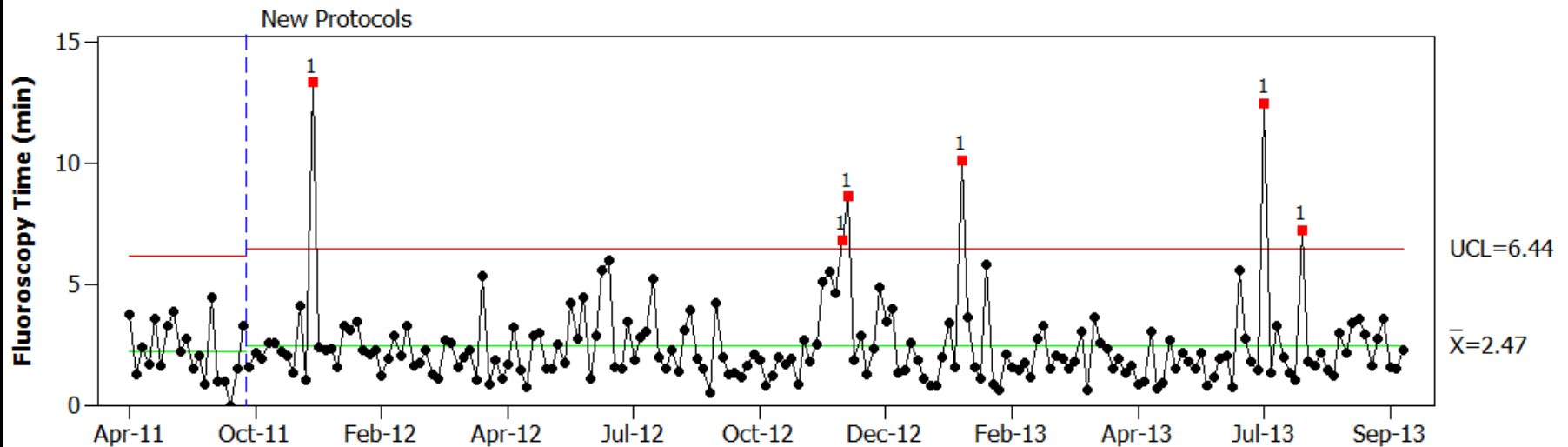

In contrast, the new protocols had little if any impact on fluoroscopy time. We interpret longer than expected fluoroscopy time as evidence of a more difficult than normal procedure. The graph illustrates 6 such cases, only 1 of which had a higher than expected reference point air kerma. In all, 15 cases had evidence of higher than expected fluoroscopy time, reference point air kerma or kerma area product.

Investigation for Causal Factors

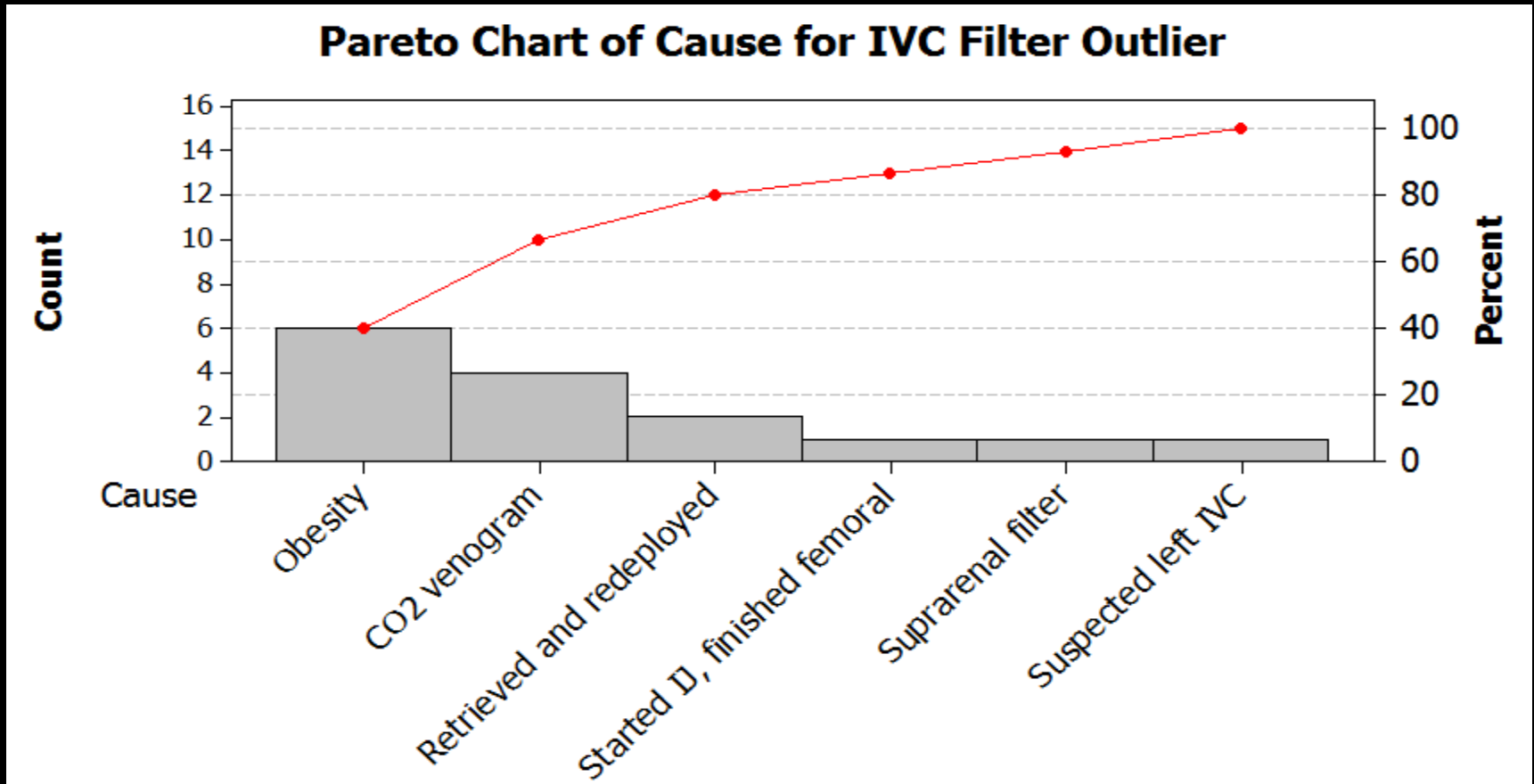

Reports and imaging studies of the 15 cases were reviewed for possible causal factors. Obesity was defined as anteroposterior abdominal diameter of >30cm and was identified in 6 of the 16 cases.

Factors Influencing Radiation Use

Taken from NCRP 168

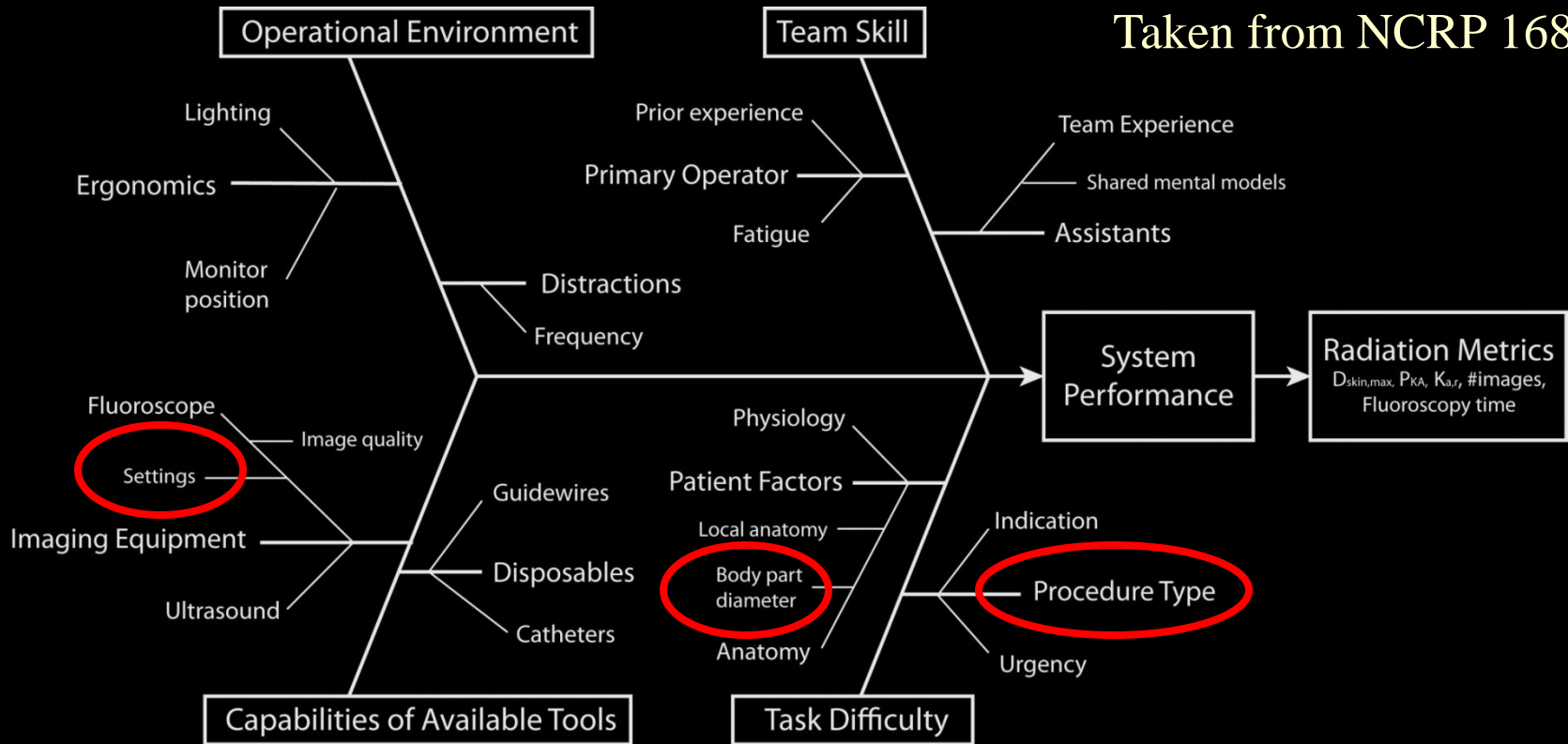

This data illustrates how multiple factors impact system performance as measured using parameters of radiation use. Data on procedure type, imaging protocols and patient factors will need to be part of any model which attempts to predict radiation exposure during fluoroscopic procedures.

Summary

- Large scale collection of dose reports from fluoroscopic procedures is feasible
- Detailed analysis
 - Standardized method for naming procedures (string of procedure codes for IR)
 - Access to other data stored in RIS and PACS
- Value of investigating cases with large differences between observed and predicted